

# AMERICH<sup>®</sup>

## MADISON<sup>®</sup> 6030

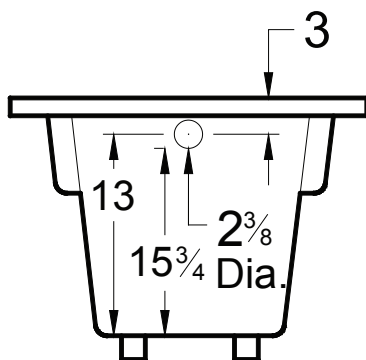
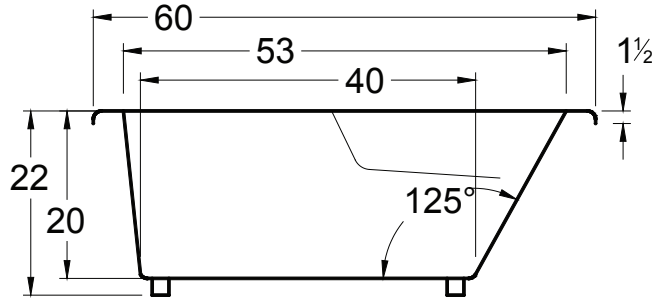
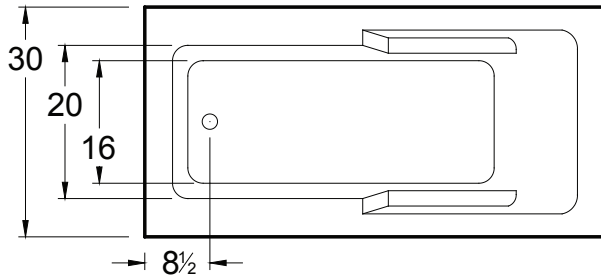

### DIMENSIONS

60" x 30" x 22" (1524 x 762 x 559 mm)

Whirlpool Operating Gallons = 35 (Liters = 133)

Gallon to Overflow = 55 (Liters = 208)

### MATERIAL

Acrylic

### TUB FLOOR

Textured

### UNDERMOUNT: Yes

- Advise Americh when ordering to ensure there are no issues with deck mounted controls.
- Always take dimensions directly from the unit.

### APPROVALS & COMPLIANCE



Americh products meet or exceed the following standards:

- Underwriters Laboratories (UL)
- Underwriters Laboratories - Canada (cUL)
- Canadian Standards Association - (CSA)
- ANSI Z124.1 • ANSI A112-19.7
- ANSI A112.19.8

Contact Americh for additional approvals.

### STANDARD EQUIPMENT

- Adjustable Feet

## BATHING SYSTEMS

## LEGEND

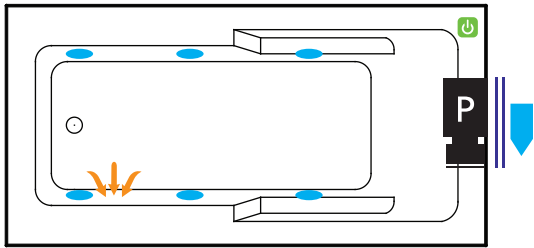

Builder Series

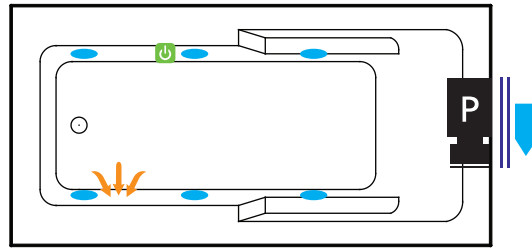

Luxury Series

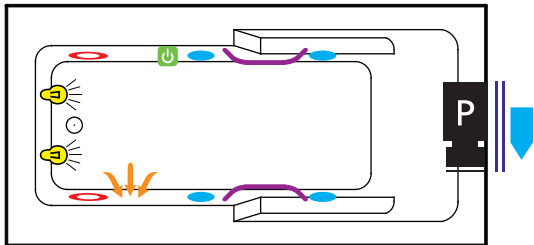

Platinum Series

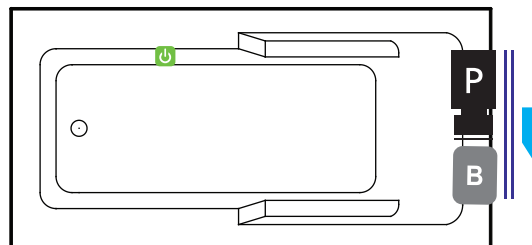

Combination  
(pump and blower location only)

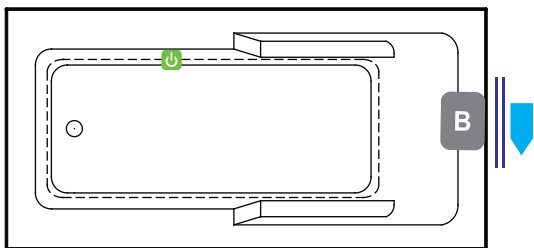

Airbath System II

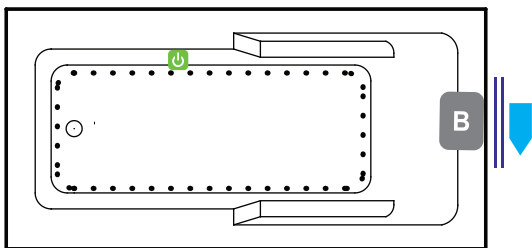

Airbath System V



Pump



Blower



Jet



Rotary Jet



Suction



Light



ON/OFF Control



Grab Bar



Access Panel  
(Minimum 16" X 20")



Label

## OPTIONAL ACCESSORIES

- ANEX (Americh Nanobubble Experience)
- Apron
  - Flat Panel
  - Removable Panel
  - Urban Storage Tray Available
- Chromatherapy
- Grab Bars: 9" - 14" - 16"
- High Density Insulation
- iBath Sound System
- Inline Heater (whirlpool only)
- Jets: Additional or Rotary
- Ozone System (whirlpool and/or Airbath only)
- Pillows: 12" - Angle
- Remote Control Upgrade (select series only)
- Serenity Soak (tub only)
- Thermal Comfort System  
(TCS cannot be used with VSM)
- Trim Kit Upgrade
- Vibro Sonic Massage  
(VSM cannot be used with TCS)
- Waste & Overflows Upgrades
  - Cable Drive Waste & Overflow
  - PVC Waste & Overflow
  - Linear Waste & Overflow

(\* ) STANDARD ON PLATINUM SERIES

## INSTALLATION TIPS

- 1) Install according to Owner's Manual and local codes.
- 2) Any tub with whirlpool, Airbath<sup>®</sup> or ANEX system requires an access panel.
- 3) Hot water supply should be 65-75% of tub capacity or greater.
- 4) Cut Dimensions: 2" Smaller than Size of tub. It is recommended to wait for unit to arrive before cutting.
- 5) Always consult your local plumber for recommendations as installations will vary.
- 6) The combination of multiple systems and options may require components to stick out and/or be remotely installed in the field.
- 7) All specifications are subject to change without notice.
  - Certain options or altering the pump/blower location may cause the pump/blower to extend beyond the tub decking.
  - Factory installed aprons may increase the overall height of the tub when ordered with certain accessories (ie. Linear Drain).
- 8) Center Drain tubs with Linear Drain option may not use 9" Grab Bar option. Only the 14" or 16" Grab Bar option is available on these units.

## ELECTRICAL REQUIREMENTS

Americh recommends one 20 amp ground fault circuit interrupter (GFCI) for each power supply provided with the bathtub.